

# *To Protect and To Serve?*

## Analyzing Entity-Centric Framing of Police Violence



**Caleb Ziems**, Diyi Yang



EMNLP 2021 Findings



# Background

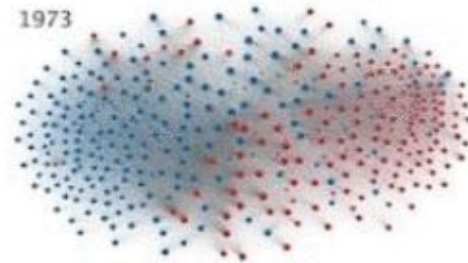

1973

House of Representatives, Voting Alignment

# Background



## Shooting of black teen in Dallas suburb did not meet 'our core values,' police chief says

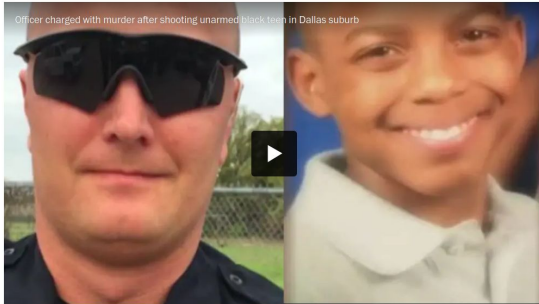

A suburban Dallas police officer was charged with murder after killing 15-year-old Jordan Edwards on April 29. (Monica Akhtar/The Washington Post)

MOST READ NATIONAL



- 1 NAACP says it's a 'paralytic' move
- 2 Welcome back to school wearing fatigues.



## Teen Shot Dead By Police As His Car Was Driving Away, Chief Says



## Texas Town Gathers to Grieve for Teenager Fatally Shot by Officer



DAILY NEWS  
NEW YORK'S HOMETOWN NEWSPAPER — Learn About Subscriptions

SEARCH

1 scare that led to agency landing at arda Airport was just...

2 Staten Island teen shoots mother to death with father's gun during crazed quarrel...

3 John Sterling and Suzyn Waldman had seen enough of inconsistent Yankees

4 Look what's inside the bill, please: The details of the \$3. trillion package

## Family of 15-year-old boy fatally shot by Texas cop demand answers after conflicting stories emerge

LOCAL

## 'Great kid' killed in officer-involved shooting in Balch Springs

# Background

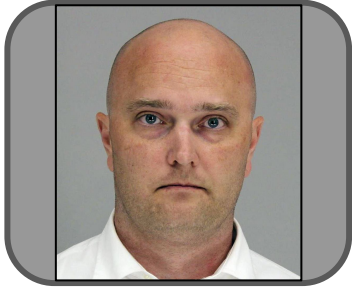

**Age**  
15

**Armed**  
False

**Attack**  
False

**Gender**  
Male

# Background

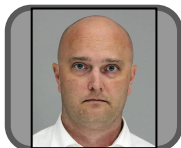

**Verdict**  
Guilty of murder

## Balch Springs police fire Officer Roy Oliver, who fatally shot Jordan Edwards with rifle



Leaning

Right-Center

Source



Official

Three days after he killed an **[unarmed]**<sup>unarmed</sup> **[15-year-old]**<sup>age</sup> **[boy]**<sup>gender</sup>, a Balch Springs police officer was fired.

“From our policies, which I went by, there were violations. I acted on them,” **[Balch Springs Police Chief Jonathan Haber said]**<sup>official\_sources</sup> Tuesday evening.



**Age**  
15

**Armed**  
False

**Attack**  
False

**Gender**  
Male

**Race**  
Black

# Background



**Verdict**  
Guilty of murder

## Jordan Edwards case:

**[Killer]**<sub>moral-harm</sub> cop had reckless past



A police officer is charged and jailed for murder and a family and community say goodbye to a child as the saga over the police shooting of **[unarmed]**<sub>unarmed'</sub> **[Black]**<sub>race</sub> **[15-year-old]**<sub>age</sub> Jordan Edwards continues.

“What the Edwards family is experiencing ... no parent wants that phone call,” **[the family’s pastor M.L. Dorsey said.]**<sub>unofficial\_sources</sub>

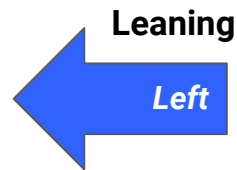

**Source**



**Unofficial**



**Age**  
15

**Armed**  
False

**Attack**  
False

**Gender**  
Male

**Race**  
Black

# Our Contributions

1. The **POLICE VIOLENCE FRAME CORPUS**
  - a. 82k News Articles
  - b. 7k Police Shootings
2. *Syntax-Aware* Methods for Automatic Frame-Extraction
3. Novel Frame Analysis
  - a. Entity-Centric
  - b. Sensitive to Frame Ordering
  - c. media framing  $\longleftrightarrow$  offline events

# 1. Building the POLICE VIOLENCE FRAME CORPUS





# 1. Building the POLICE VIOLENCE FRAME CORPUS

	Left	Left-Center	Least Biased	Right-Center	Right
# Articles	1,090	9,761	5,214	3,993	1,009



## 2. Automatic Frame Extraction

# Syntax-Aware Frame Extraction

Partitioning:

✨neuralcoref

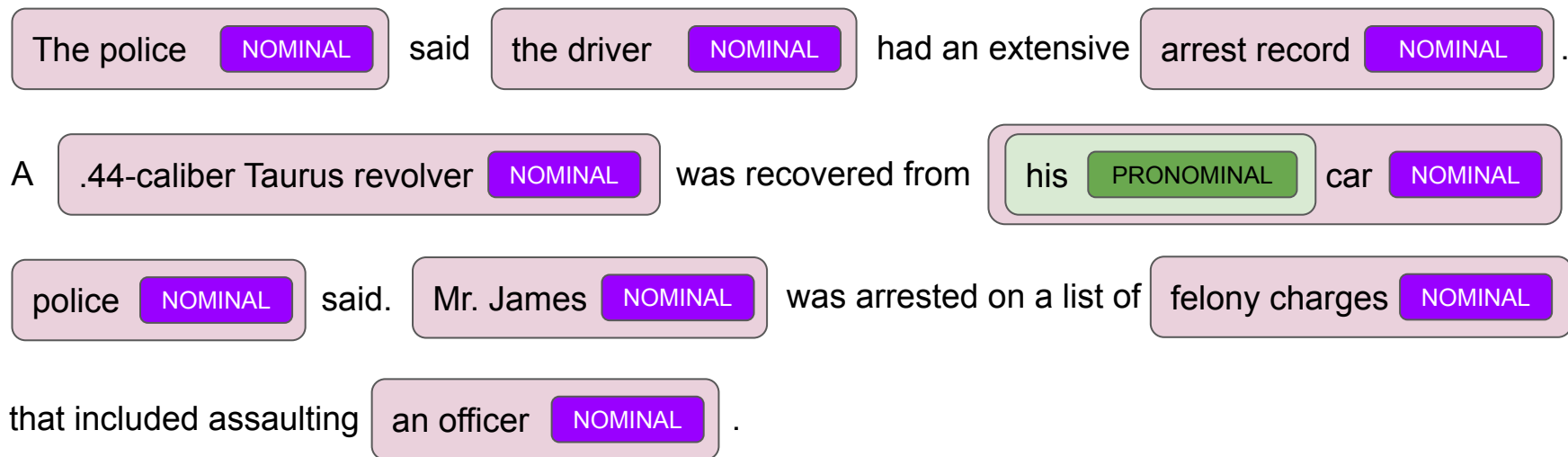

# Syntax-Aware Frame Extraction

Partitioning:

match

- + name
- + age
- + gender

✨neuralcoref

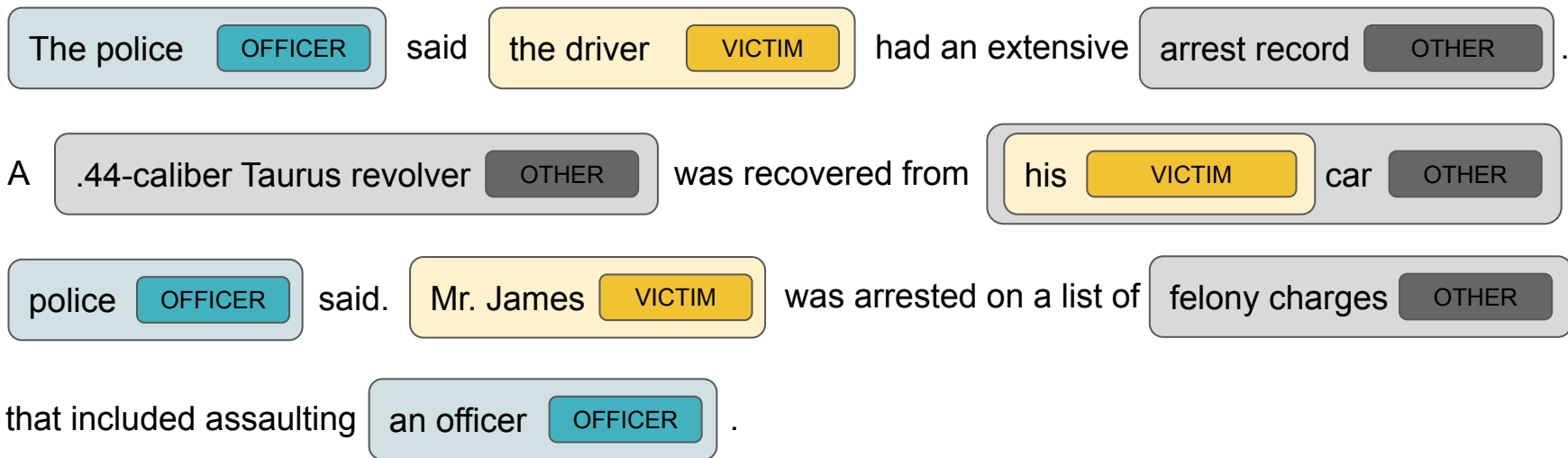

# Syntax-Aware Frame Extraction

Partitioning:

neuralcoref

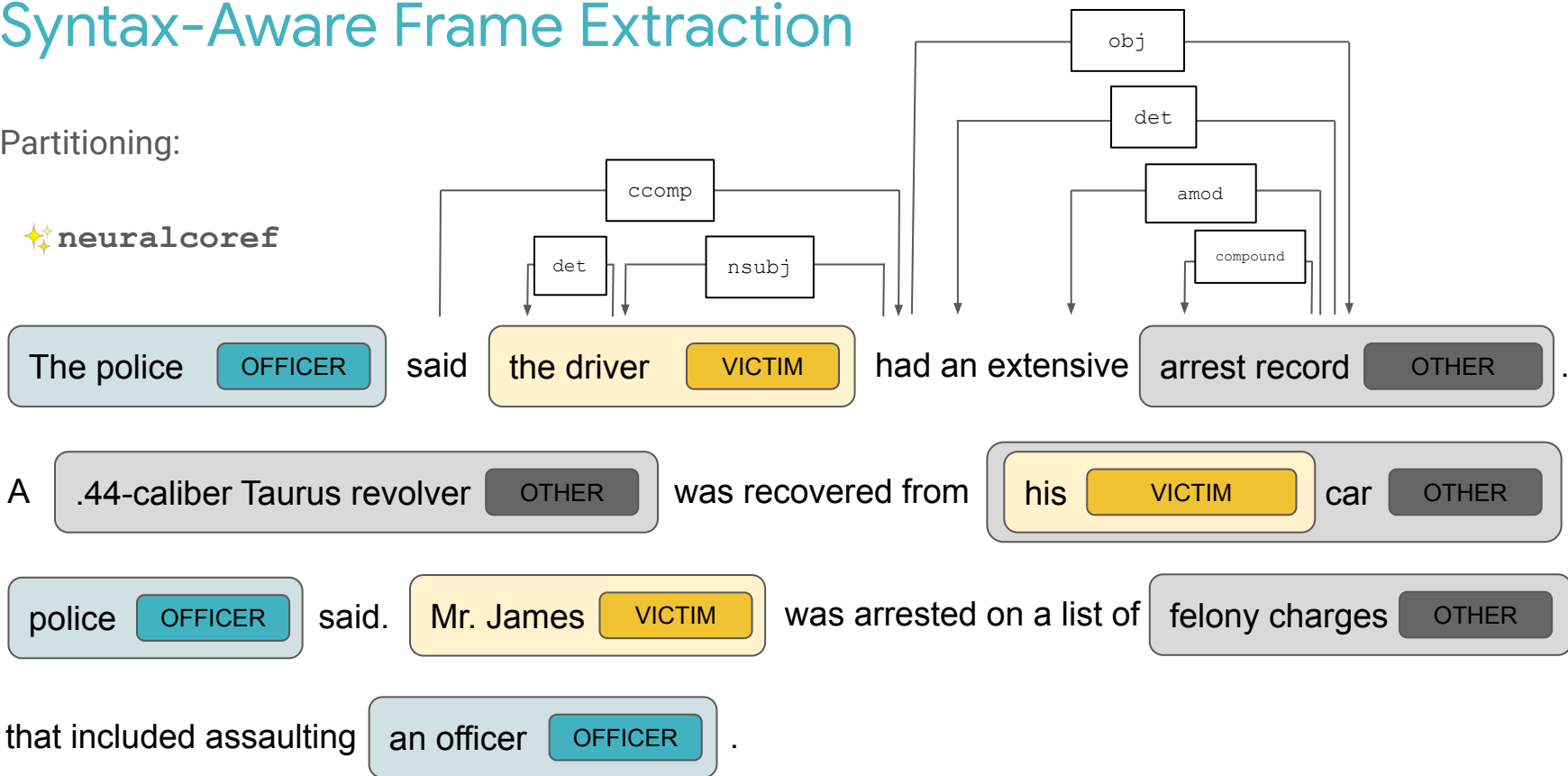

## 2. Automatic Frame Extraction

> Age, Gender, and Race

*syntax*

Armed or Unarmed

Attacking or Fleeing

Criminality

Mental Illness

Legal Language

Official and Unofficial Sources

Systemic Racism

Video

## 2. Automatic Frame Extraction

> Age, Gender, and Race

*syntax*

Armed or Unarmed

Attacking or Fleeing

Criminality

Mental Illness

Legal Language

Official and Unofficial Sources

Systemic Racism

Video

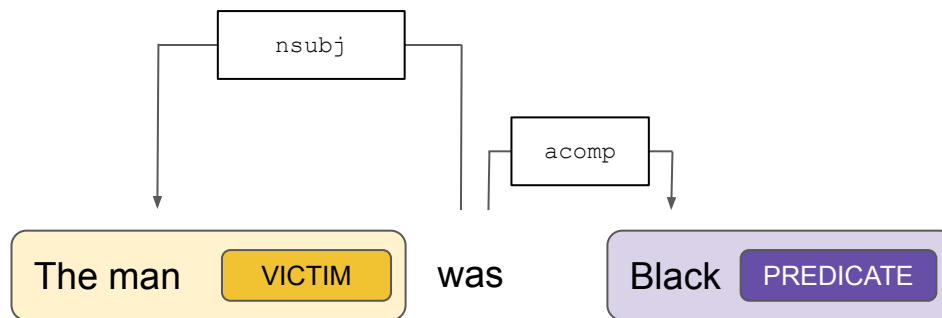

## 2. Automatic Frame Extraction

Age, Gender, and Race

> Armed or Unarmed

*regex*

Attacking or Fleeing

Criminality

Mental Illness

Legal Language

Official and Unofficial Sources

Systemic Racism

Video



## 2. Automatic Frame Extraction

Age, Gender, and Race

Armed or Unarmed

> **Attacking or Fleeing**

*syntax*

Criminality

Mental Illness

Legal Language

Official and Unofficial Sources

Systemic Racism

Video

## 2. Automatic Frame Extraction

Age, Gender, and Race

Armed or Unarmed

> Attacking or Fleeing

*syntax*

Criminality

Mental Illness

Legal Language

Official and Unofficial Sources

Systemic Racism

Video

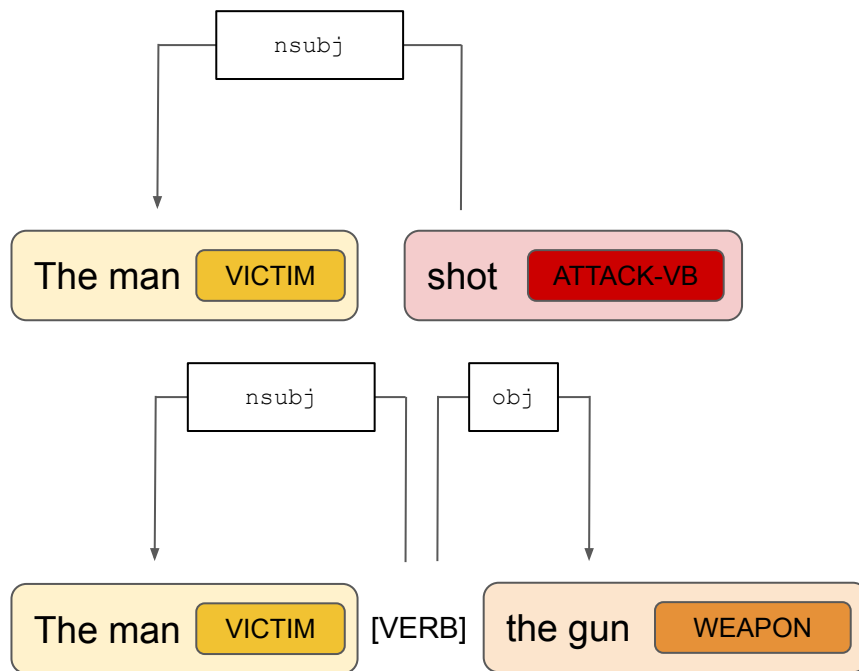

## 2. Automatic Frame Extraction

Age, Gender, and Race

Armed or Unarmed

Attacking or Fleeing

> **Criminality**

*lexicon*

Mental Illness

Legal Language

Official and Unofficial Sources

Systemic Racism

Video

## 2. Automatic Frame Extraction

Age, Gender, and Race

Armed or Unarmed

Attacking or Fleeing

Criminality

**> Mental Illness**

*lexicon*

Legal Language

Official and Unofficial Sources

Systemic Racism

Video

## 2. Automatic Frame Extraction

Age, Gender, and Race

Armed or Unarmed

Attacking or Fleeing

Criminality

Mental Illness

> Legal Language

*lexicon*

Official and Unofficial Sources

Systemic Racism

Video

## 2. Automatic Frame Extraction

Age, Gender, and Race

Armed or Unarmed

Attacking or Fleeing

Criminality

Mental Illness

Legal Language

> Official and Unofficial Sources

*syntax*

Systemic Racism

Video

## 2. Automatic Frame Extraction

Age, Gender, and Race

Armed or Unarmed

Attacking or Fleeing

Criminality

Mental Illness

Legal Language

> Official and Unofficial Sources

*syntax*

Systemic Racism

Video

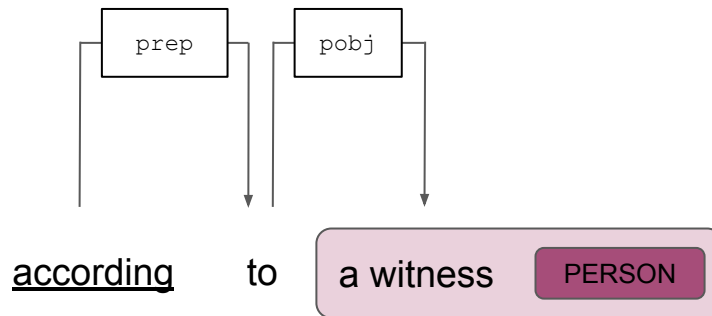
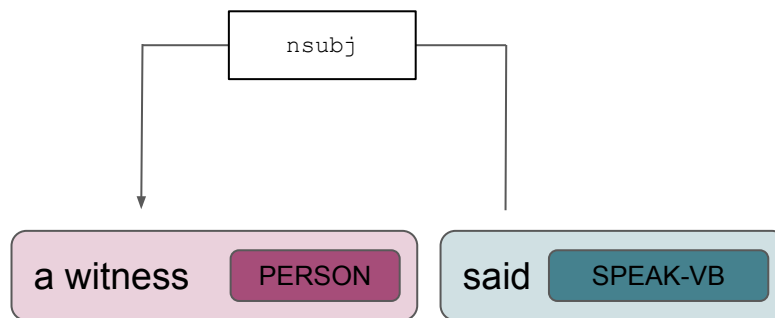

## 2. Automatic Frame Extraction

Age, Gender, and Race

Armed or Unarmed

Attacking or Fleeing

Criminality

Mental Illness

Legal Language

Official and Unofficial Sources

> **Systemic Racism**

***syntax***

Video



## 2. Automatic Frame Extraction

Age, Gender, and Race

Armed or Unarmed

Attacking or Fleeing

Criminality

Mental Illness

Legal Language

Official and Unofficial Sources

> Systemic Racism

*syntax*

Video

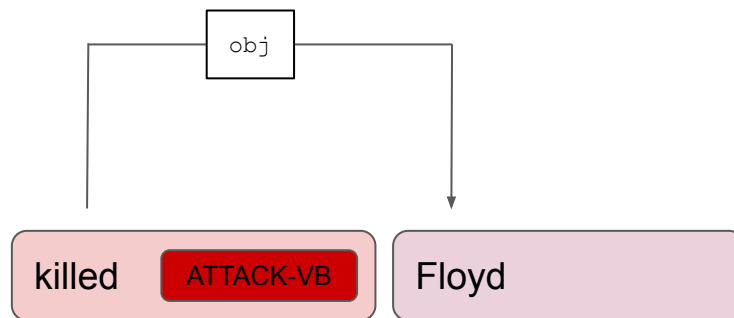

## 2. Automatic Frame Extraction

Age, Gender, and Race

Armed or Unarmed

Attacking or Fleeing

Criminality

Mental Illness

Legal Language

Official and Unofficial Sources

Systemic Racism

> **Video**

*regex*

# 3. Frame Analysis

---

## **Framing Device**

---

Age

Armed

Attack

Criminal record

Fleeing

Gender

Legal language

Mental illness

Official sources

Race

Systemic

Unarmed

Unofficial sources

Video

---

### 3. Frame Analysis

Framing Device	Inclusion			Ordering		
	Lib.	Cons.	<i>p</i>	Lib.	Cons.	<i>p</i>
Age	0.472	<b>0.764</b>	***	<b>0.480</b>	0.467	
Armed	0.439	<b>0.588</b>	***	0.313	<b>0.358</b>	*
Attack	0.369	<b>0.539</b>	***	0.267	<b>0.306</b>	
Criminal record	0.613	<b>0.655</b>	*	<b>0.294</b>	0.278	**
Fleeing	0.228	<b>0.336</b>	***	<b>0.246</b>	0.217	
Gender	0.610	<b>0.620</b>	***	0.611	<b>0.622</b>	
Legal language	0.875	<b>0.919</b>	***	<b>0.523</b>	0.419	***
Mental illness	<b>0.181</b>	0.145	*	0.301	0.296	
Official sources	0.586	<b>0.808</b>	***	<b>0.194</b>	0.163	***
Race	<b>0.428</b>	0.214	***	<b>0.296</b>	0.233	***
Systemic	<b>0.428</b>	0.291	***	<b>0.410</b>	0.283	***
Unarmed	<b>0.195</b>	0.110	***	0.408	<b>0.470</b>	
Unofficial sources	0.708	<b>0.780</b>	**	<b>0.184</b>	0.163	***
Video	0.164	<b>0.191</b>		0.283	<b>0.436</b>	***

### 3. Frame Analysis

Framing Device	Inclusion			Ordering		
	Lib.	Cons.	<i>p</i>	Lib.	Cons.	<i>p</i>
Age	0.472	<b>0.764</b>	***	<b>0.480</b>	0.467	
Armed	0.439	<b>0.588</b>	***	0.313	<b>0.358</b>	*
Attack	0.369	<b>0.539</b>	***	0.267	<b>0.306</b>	
Criminal record	0.613	<b>0.655</b>	*	<b>0.294</b>	0.278	**
Fleeing	0.228	<b>0.336</b>	***	<b>0.246</b>	0.217	
Gender	0.610	<b>0.620</b>	***	0.611	<b>0.622</b>	
Legal language	0.875	<b>0.919</b>	***	<b>0.523</b>	0.419	***
Mental illness	<b>0.181</b>	0.145	*	0.301	0.296	
Official sources	0.586	<b>0.808</b>	***	<b>0.194</b>	0.163	***
Race	<b>0.428</b>	0.214	***	<b>0.296</b>	0.233	***
Systemic	<b>0.428</b>	0.291	***	<b>0.410</b>	0.283	***
Unarmed	<b>0.195</b>	0.110	***	0.408	<b>0.470</b>	
Unofficial sources	0.708	<b>0.780</b>	**	<b>0.184</b>	0.163	***
Video	0.164	<b>0.191</b>		0.283	<b>0.436</b>	***

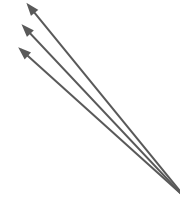

**conservative**  
strategies that justify  
police conduct

### 3. Frame Analysis

Framing Device	Inclusion			Ordering		
	Lib.	Cons.	<i>p</i>	Lib.	Cons.	<i>p</i>
Age	0.472	<b>0.764</b>	***	<b>0.480</b>	0.467	
Armed	0.439	<b>0.588</b>	***	0.313	<b>0.358</b>	*
Attack	0.369	<b>0.539</b>	***	0.267	<b>0.306</b>	
Criminal record	0.613	<b>0.655</b>	*	<b>0.294</b>	0.278	**
Fleeing	0.228	<b>0.336</b>	***	<b>0.246</b>	0.217	
Gender	0.610	<b>0.620</b>	***	0.611	<b>0.622</b>	
Legal language	0.875	<b>0.919</b>	***	<b>0.523</b>	0.419	***
Mental illness	<b>0.181</b>	0.145	*	0.301	0.296	
Official sources	0.586	<b>0.808</b>	***	<b>0.194</b>	0.163	***
Race	<b>0.428</b>	0.214	***	<b>0.296</b>	0.233	***
Systemic	<b>0.428</b>	0.291	***	<b>0.410</b>	0.283	***
Unarmed	<b>0.195</b>	0.110	***	0.408	<b>0.470</b>	
Unofficial sources	0.708	<b>0.780</b>	**	<b>0.184</b>	0.163	***
Video	0.164	<b>0.191</b>		0.283	<b>0.436</b>	***

**liberal** strategies that emphasize systemic racism

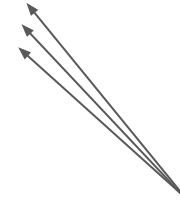
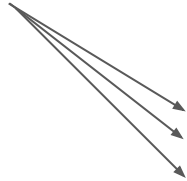

**conservative** strategies that justify police conduct

### 3. Frame Analysis

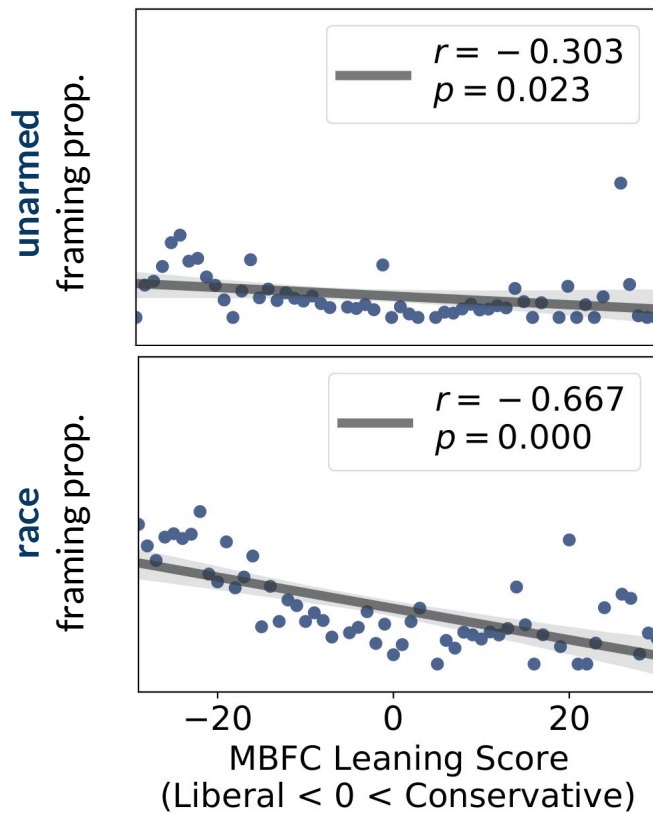
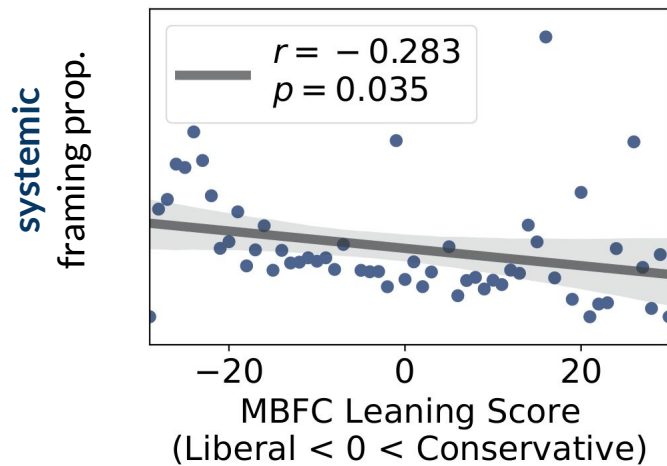

### 3. Frame Analysis

See Paper for more details

+ *Moral Foundations* and *Linguistic Style* Analysis



# The Broader Scope of Media Framing

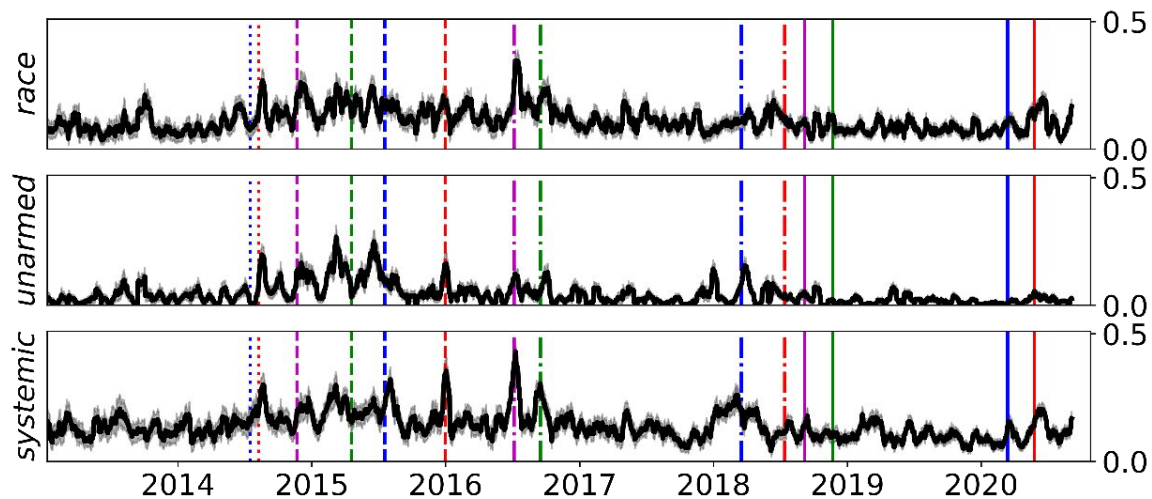



[calebziems.com](http://calebziems.com)



[@cjziems](https://twitter.com/cjziems)



[cc.gatech.edu/~dyang888/](http://cc.gatech.edu/~dyang888/)



[@Diyi\\_Yang](https://twitter.com/Diyi_Yang)

# Thanks!

Please reach out



GT-SALT/[framing-police-violence](https://github.com/GT-SALT/framing-police-violence)